

Author:	YeboTech (Pty) Ltd
---------	--------------------

## 1. INTRODUCTION

### 1.1. Quick-start

- For reference guides, see Appendices 17-21.
- For USB installation, see section 7.
- For GSM installation, see section 8.

### 1.2. Overview

The Yebo Multi-function Station (MFS) is used to connect Yebo Keys to the Yebo Management System web site, enabling the user to capture locks and keys, manage key authorizations, collect audit trails, and enable time-based functions such as time windowing and multi-keying. It may also be used in a stand-alone PIN mode to activate keys out of time window. Depending on hardware configuration communication with the server can take place via a USB Windows workstation or GSM. Automatic failover from one channel to another is also supported.

### 1.3. Configurations

The base MFS unit supports key-powered PIN mode for emergency activation of keys out of time window, and USB sync via a Microsoft Windows™ workstation running the YSSController software.

A GSM module may be installed to support sync via the GSM network. The module may use an internal antenna, or optionally an external antenna may be installed by drilling holes in the unit housing.

All configurations support use of an internal battery that may be recharged via the USB port. In PIN mode this provides a larger and brighter screen. The battery supports stand-alone sync via GSM for about two days.

In GSM mode without battery support power may be supplied via a 1.5A micro-USB plug power supply.

### 1.4. Scope

This manual describes the installation, configuration, use and trouble-shooting of all variants of the MFS, including the YSSController software.

The information contained herein is intended for those who need to install, support and maintain sync station services, or advanced users wishing to obtain a deeper understanding of the product than is provided by the product information leaflets.

## 1.5. Table of Contents

1. Introduction.....	1
2. Documentation.....	1
3. Basic Concepts.....	2
4. Mounting Options.....	3
5. Installing a USB Sync Station .....	5
6. Running the USB Controller .....	7
7. Running the USB Client.....	8
8. Installing a GSM Sync Station .....	10
9. Registering a Sync Station .....	12
10. Battery .....	13
11. Service Failover.....	14
12. PIN Mode.....	14
13. Device illumination.....	15
14. Unit Reset.....	15
15. Multilingual Support .....	15
16. Trouble-Shooting .....	16
17. APPENDIX: Command Switches.....	17
18. APPENDIX: Keypad Reference .....	18
19. APPENDIX: Status icons .....	19
20. APPENDIX: Configuration Menus.....	19
21. APPENDIX: Supported Characters.....	20

## 2. DOCUMENTATION

### 2.1. Product Data Sheets

The product data sheets contain summary information about each product obtainable from [www.yebotech.com](http://www.yebotech.com). The products applicable to this manual are:

Product	Reference
MFS station	YT-MFS-DS-2.0
MFS GSM module	YT-MFS_GSM-DS-1.0

### 2.2. Software

YSSController software v. 2.4 or later is required to support the USB sync station. It may be downloaded from the sync station product support page on [www.yebotech.com](http://www.yebotech.com).

### 3. BASIC CONCEPTS

#### 3.1. Product Overview

The location of the sync station within the larger system is summarized in the context diagram below.

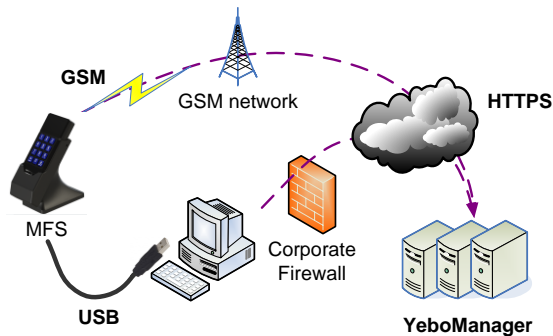

The sync station contains a *plug* into which a key may be inserted. A properly configured sync station will display 'Ready' or the configured site name.

When a key is inserted into the plug the sync station's job is to securely connect the key to the Yebomanager web site. Yebotech's standard site is at <https://secure.yebotech.com>, but customers with special security needs may run their own sites.

Once connected the web site performs the necessary transactions and then closes off by displaying the status of the key: this usually involves displaying the name of the user to whom the key has been issued, plus any useful information such as which location and for what time period the key is authorized.

The sync station can connect to the web site in one of two ways:

1. Using a host Microsoft Windows workstation that has access to the [secure.yebotech.com](https://secure.yebotech.com) web site. This mode is supported by the base MFS configuration. No special USB driver is required, but it is necessary to run the 'controller' software on the host workstation. The various USB installation options are discussed section 5.2 *USB Installation Options*.
2. Via a GSM cellular network. This requires installation of the GSM plug-in into the MFS base configuration. The GSM module can be used with an internal antenna or an external patch antenna for wall-mounted applications. A standard (1FF 25mm x 15mm) SIM card must be installed in a side slot which attracts a monthly network charge. The GSM module may be powered by a battery and/or a 1.5A USB power supply.

In addition the MFS unit may also be used in an emergency PIN mode (see section 12), which may be used as a fall-back in the event communications to the server fails or even if the unit has lost all power. PIN mode enables a user to activate an expired key by entering a personal identification number (PIN); the duration and number of times this may be done depends on the key's security configuration. If the unit had lost all power it is powered by the key alone in a reduced display mode.

The MFS unit supports installation of an internal battery. When being used as a stand-alone PIN station the battery supports a larger and brighter display, as well as backlighting the keypad and plug illumination. When used with GSM the battery provides a backup in the event of power failure. The battery recharges when the unit is plugged into USB power.

#### 3.2. USB vs. GSM

The choice of USB or GSM depends on the site requirements. The pros and cons of each option are summarized in the table below.

In a corporate environment a USB sync station solution can be quite problematic to install and support. Corporate security policies frequently restrict use of USB ports, may require opening of firewalls to access the Yebomanager server, and installers may have difficulty obtaining rights to properly install the controller software on the host workstation. In a work environment a reliable host workstation is also sometimes hard to identify and their maintenance depends a great deal on the quality of the resident management and staff. These factors should be assessed prior to advancing a USB solution.

In smaller stand-alone environments where one individual is responsible for maintaining the sync station, a USB solution may be eminently practical.

Sites that require a very high degree of reliability should consider GSM as the preferred solution. GSM networks are typically reliable but some locations may have poor signal, in which case a wall-mounted solution with an external patch antenna should be considered.

The MFS unit supports fail-over from USB to GSM if both routes are enabled. In this case the unit uses USB if available, and then fails to GSM in the event there is a problem with the USB route. This solution provides a degree of network redundancy.

	USB	GSM
<i>Installation</i>	Requires: <ul style="list-style-type: none"> <li>• MS Windows host computer</li> <li>• Available USB port</li> <li>• Network access to YeboManager</li> <li>• Run YSSController software</li> <li>• Administrator rights to install as service</li> </ul>	Requires: <ul style="list-style-type: none"> <li>• Installation of GSM module</li> <li>• SIM card for GSM network</li> <li>• Battery and/or +5V/1.5A USB supply</li> </ul>
<i>Support</i>	Less robust: people fiddle, un-plug devices, turn off computers, loose network connectivity, experience power outages.	Very robust. Battery backup is good for at least 24 hours power outage.
<i>Cost</i>	Cheapest.	Attracts monthly cellular network charge.
<i>Security</i>	Less secure. The secure link to the web server is decrypted by the YSSController software and is potentially vulnerable to interception by malicious applications on the host workstation.	Most secure.
<i>Speed</i>	About the same, between 20-40 messages per second depending on network quality.	

**3.3. Network load**

A sync station typically generates less than 4kb of traffic per 100 audited transactions. A site with 100 locks and 20 keys typically generates less than 1,000 transactions a day, so the monthly sync station network traffic is usually well under 2MB per month. This is usually inconsequential in a corporate or GSM network. Note that the quality and congestion on a corporate network can vary significantly, and if possible corporate IT should prioritize traffic to and from sync stations.

**3.4. Cost**

There is an additional cost for the GSM plug-in module, but this additional cost over the base unit is typically not a factor for larger sites.

The GSM sync station attracts a nominal monthly network connection charge, plus a data charge. This will vary from network to network but will typically be significantly less than a standard cell phone contract. A busy sync station is unlikely to use more than 2MB of data per month, which is usually an inconsequential cost.

1. **Hand-held.** A unit that is required to be hand-held and mobile may be fitted with a rubber sleeve.
2. **Wall mount.** A fixed unit may be mounted on a wall using the wall mount bracket.
3. **Desk mount.** The unit may be mounted in a desk mount, presenting the device to a user at an ergonomic angle. This configuration may optionally be used as a docking station by not fitting the wall mount cap.



Figure 1: Hand-held and wall mount options

**4. MOUNTING OPTIONS**

**4.1. Mounting options**

There are three main mounting options:



Figure 2: Desk mount docking station option

**4.2. Hand-held**

In hand-held operation it is advisable to use a provided rubber sleeve to protect the unit from rough handling. The sleeve covers both the SIM slot and the USB charging port to limit dust and water ingress.

When charging the unit, the sleeve may be easily slipped off the base to permit insertion of the USB plug.

**4.3. Wall mount**

The wall mount consists of a base docking unit and a securing cap. The base unit may be secured using screws or double-sided tape.

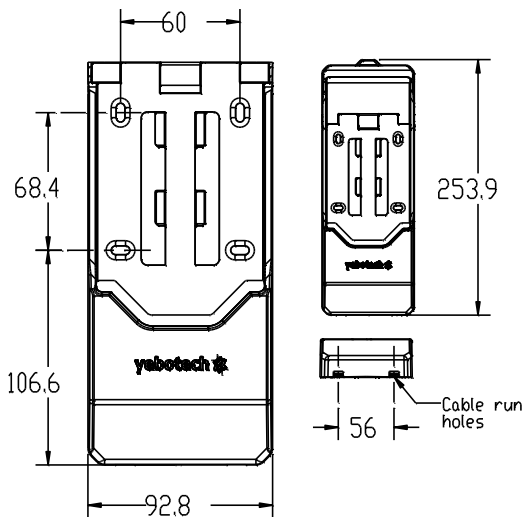

Figure 3: Wall mount dimensions

To install, first secure the docking unit using the screw holes provided. The screw holes are slotted to accommodate significant misalignment of at least one of the holes as sometimes occurs when installing wall plugs. Use the base unit as a template and mark the

centre of each slot prior to drilling. After drilling the holes the unit may be seated on the screws.

To secure with double-sided tape, place tape on the flat backs of the base unit.

Prior to securing the wall mount to the wall, if using a USB cable zigzag the cable through the cable through the three cable retention pins to provide pull protection, then run the cable out one of the two cable run holes at the base. Leave enough slack in the plug cable to allow easy removal and re-attachment of the station to power without having to remove the wall mount.

After docking the station in the wall mount base it may be secured by clipping on the wall mount cap. Ensure the clips are properly aligned before seating the cap.

**4.4. Desk mount**

The desk mount consists of a pedestal designed to host the wall mount unit, plus a separate base that may be fastened to a flat surface using either screws or double-sided tape.

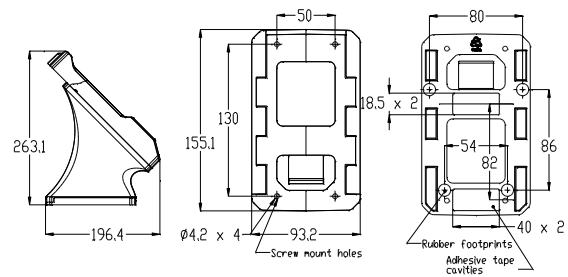

Figure 4: Desk mount dimensions

To fix the base using screws, fasten the base using the four screws provided.

To fix the base using double-sided tape, cut the tape to length and place in the adhesive tape cavities provided before securing to the surface.

The wall mount unit is fixed to the pedestal by placing the two pedestal halves together and sliding the wall mount onto the pedestal clips. The pedestal + wall mount unit is then slid onto the base to secure. This makes for easy removal for cleaning or service.

**4.5. Removal of the wall mount cap**

The wall mount cap is designed to clip securely into the wall mount base.

Removal of the cap requires a tool with a chamfered tip to be slipped into the groove at the back of the wall-mount base to release the securing clip. Use a rectangular strip of plastic 3.8mm x 1.2mm x 120mm so as not to mark paint or drywall.

**4.6. Security of the wall mount**

The wall mount is designed to provide some protection against weather but is not intended for an exposed outdoor location.

Since the wall mount is made of plastic it provides only limited protection against forceful attack.

**5. INSTALLING A USB SYNC STATION**

**5.1. Requirements**

The following checklist should be cleared prior to installing a USB sync station:

Requirement	Description	Ok?
Host computer	A Microsoft Windows workstation Windows XP or later.  <b>Check:</b> Start / Right click 'Computer', check Windows edition. Windows XP, Vista, Win 7/8/10 are all acceptable.	
Internet access	Access to secure.yebotech.com.  <b>Check:</b> Open a web browser and type 'secure.yebotech.com' into the address line. The web site home page should display.  Troubleshooting: see section 16.1, <i>Configuring the Network</i> .	
USB port	An available and powered USB port.  <b>Check:</b> Plug in the USB sync station. The power icon should come on the Windows should detect the device.	
Administrator access	Access to an account with administrator access.  Note: this may only be required for installation as a service. See section 5.2, <i>USB Installation Options</i> .  <b>Check:</b> Start / Control Panel / User Accounts / Change Your Account Type. If 'Administrator' is not selected then it is not an administrator account.	

Install software	The install file. See section 5.3, <i>Obtaining YSSController Software</i> .	
------------------	--	--

**5.2. USB Installation Options**

The USB sync station requires the 'controller' software to be run on the host computer. No special USB driver is required.

There are three install options:

1. Don't install. Copy YSSController.exe to the computer and run in a regular user account. This does not require administrator rights and no installation is required. See section 5.4, *Option 1: Copy Executable*.
2. Install YSSController as a regular user application. This may require administrator access depending on corporate policies. YSSController will only run when the nominated user is logged in. This may be preferred if the site does not wish the sync station to be operable unless a nominated user is authenticated. See section 5.5, *Option 2: Install as a user application*.
3. Install YSSController as a system service. This requires administrator rights to install. YSSController will start running as soon as the workstation is booted and does not require anyone to log in. This is the most robust and recommended solution. See section 5.6, *Option 3: Install as a service*.

From a support perspective the last option is preferred.

**5.3. Obtaining YSSController Software**

The latest YSSController install can be obtained from <https://secure.yebotech.com/> and click 'Help'.

**5.4. Option 1: Copy Executable**

Use this option if you are unable to obtain administrator rights to the host workstation, but for which a user has been nominated to be logged in for the sync station to function.

Note: Copying an executable file to a corporate computer may be contrary to security policies. This should be cleared with local IT management first.

To obtain the YSSController.exe application you must first run the downloaded install on a workstation on which you have install rights (see Option 2: Install as a user application). YSSController.exe can then be copied from the path "C:\Program Files\YeboTech\YSSController" (or "C:\Program Files (x86)\YeboTech\YSSController" on a 64-bit operating system).



The installation procedure is then as follows:

1. Log into the host workstation using the nominated user account.
2. Copy YSSController.exe to a suitable location. A suggested location is "<User Folder>\Software\YeboTech".
3. Click Windows Start menu, All Programs, right-click 'Startup' and 'Open'. Then right-click on the YSSController.exe in its copied location and drag into the Startup folder, and select "Create shortcuts here". This will cause YSSController to be run whenever the user logs in.
4. Repeat the process above to create a link on the user's desktop. This will enable the user to manually start the application if necessary.

**5.5. Option 2: Install as a user application**

Use this option if the site requires a designated user to be logged in for the sync station to be operable. In order to run the install you may require administrator rights, depending on corporate IT policies.

1. Log into the designated user's account.
2. Download the latest .msi file from YeboTech (see section 5.3, *Obtaining YSSController Software*).
3. Double-click on the downloaded .msi file to start the install.
4. When presented with the 'Install Options' dialog, un-check the 'Install as a service' option. See section 5.7, *Description of install options* for a full description of other available install options.
5. If requested "Do you want to allow the following program to make changes to your computer?" click 'Yes'. You may be required to enter an administrator password.
6. Click 'Finish' to complete the installation. The controller should now be running. See section 5.8, *Verifying the Installation*.

**5.6. Option 3: Install as a service**

Use this option if you wish the sync station to be operable as soon as the host computer has booted, regardless of whether or not someone is logged in. This is the preferred option from a support perspective. You will require access to an account with administrator rights.

1. Log into the Administrator account.
2. Download the latest .msi file from YeboTech (see section 5.3, *Obtaining YSSController Software*).
3. Double-click on the downloaded .msi file to start the install.

4. When presented with the 'Install Options' dialog, check the 'Install as a service' option. See section 5.7, *Description of install options* for a description of other available install options.
5. Click 'Next' and 'Finish' to complete the installation. The YSSService should now be running. See section 5.8, *Verifying the Installation*.

**5.7. Description of install options**

There are various install configurations that may be used to customize the install, presented in the options dialog during installation.

See section 6.1, *Understanding execution modes* for a full explanation.

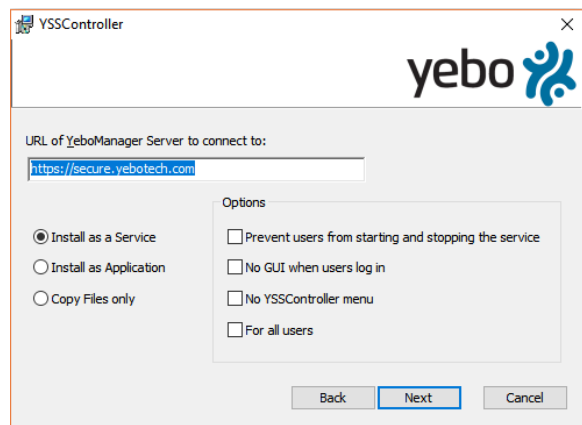

The "URL of YeboManager server to connect to" specifies the web address of the YeboManager server. The general format of the URL is:

http[s]://<address>[:port]

The URL components are:

1. **http[s].**  
If https:// is prefixed checked, the service will connect using an encrypted connection. If http:// then the connection is not encrypted. Note that unencrypted connections are often disabled on the server.
2. **<address>**  
The web address or IP address of the server, for example "secure.yebotech.com" or "41.185.29.215" are both valid.
3. **[:port].**  
An optional suffix to specify the IP port to connect to. If not specified the default port is used, specifically port 80 or 443 for http or https respectively.

The configurations are:

4. **Install as a service.** If checked, a service named YSSService is installed. The service is configured to run on start-up. Following installation the service should be running. The sync station will be accessible even if no one is logged into the computer.
5. **Install as Application**  
If selected YSSController is installed as a regular user application. The controller is only started when the installing user is logged in.
6. **Copy files only.** This may be used to unpack the application files without installing on the system. This is useful if you don't have administrator rights and need to conduct a test.

When installing the application there are various run-time options:

1. **Prevent users from starting and stopping the service.** This is only applicable if 'Install as a service' configuration is selected. If checked, ordinary users of the system will not have permission to start and stop the sync service and only an administrator will be allowed to do so.
2. **No GUI when user logs in.** The default installation displays a sync service status icon in the task tray. Select this option to make the service invisible. The service will still run however.
3. **No YSSController menu.** If checked, YSSController will not be added to the Windows applications menu.
4. **For all users.** Apply the selections for all users on a system. If not selected only the installing user will see the service status icon in the task tray and/or the application in the windows menu.

Following selection of options there are different setup types:

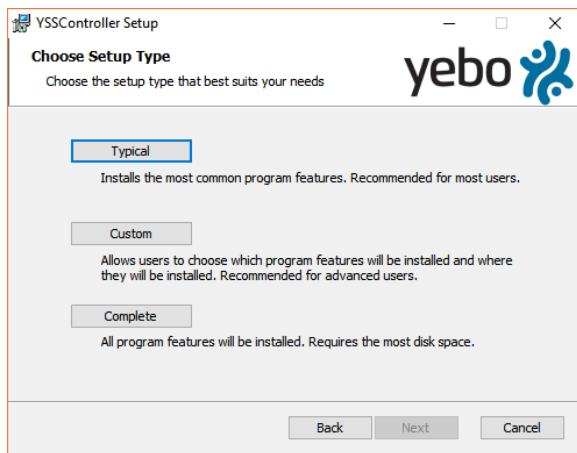

1. **Typical.** Use the system default installation options. This is the recommended method.

2. **Custom.** Provide options on which components to install and where. This is intended for expert use.
3. **Complete.** Install all components even if not strictly required.

### 5.8. Verifying the Installation

Following execution of the installation programme (configuration options 1 and 2 above), the controller should be running. The following may be checked to verify an installation:

1. If "No YSSController menu" was not checked, A new menu item will have appeared under Start / All Programs / YSSController. This menu contains links to YSSController and various support pages.
2. An icon should have appeared in the system task tray that looks like this: . See section 7.2, *Client Status Icon* if you have difficulty finding the icon.
3. If the the application was installed as a system service, a service named 'YSSController' should have been installed and started.
4. If a sync station is plugged in and the host can contact secure.yebotech.com, the sync station should display 'Pass Key:' followed by a 6-character code.

See section 6, *Running the USB Controller* and section 7, *Running the USB Client* for details on how to use the application, and section 9 for details on how to register the sync station.

## 6. RUNNING THE USB CONTROLLER

### 6.1. Understanding execution modes

The application consists of two programs: YSSService.exe, and YSSController.exe.

YSSService.exe is a 'controller' application that manages any sync stations plugged into the host computer. It is usually run as a system service. It may also be used by an administrator to configure the service installation, or it may be run as a console-mode application. See section 17.2, *YSSService.exe switches* for a description of YSSService.exe command-line options.

YSSController.exe is actually two applications in one: the 'controller', which does exactly the same job as YSSService.exe, and a 'client', which provides a graphical interface reporting the status of the controller. It is always run as a regular user application, and supports command-line options similar to YSSService.exe. See section 17.3, *YSSController.exe switches* for a description.

The 'controller' component does the actual job of controlling sync stations, and only one copy may run at a time. The controller may be run either as a Windows service (as YSSService.exe), or as a user application (in YSSController.exe).

The 'client' component simply connects to the controller version and provides the user with a means of seeing what is going on. The client is visible as an icon in the Windows system tray.

Because YSSController.exe contains both the controller and the client, exactly how it behaves when started depends on the installation options and the context in which it is launched:

1. If the application was installed as a service, YSSController.exe will always run as a client, even if the service is not running.
2. Otherwise, if there is no other controller running the YSSController.exe will run as both a controller and as a client.
3. If however there is already a controller running, then YSSController.exe runs only the client. It will attempt to connect to the controller and display the controller status.

**6.2. Overriding default behaviour**

The above behaviour may be overridden using the /controller and /client command-line switches, which force YSSController.exe to run as a controller or only as a client, respectively. See section 17.3, YSSController.exe switches for a full description.

**6.3. Starting and stopping the service**

If the application was installed as a service, a service named 'YSSController' will have been created in the list of system services. This is a background application that runs independently of any logged in user.

By default the installer configures the service to start whenever the computer is booted, and it is started as part of the installation. Normally it should not be necessary to manually start or stop the service, but it is possible to do so.

If the service was not installed with the option 'Prevent users from starting and stopping the service', then the control menu in the client interface will contain the 'Start Service' and 'Stop Service' items (see section 7.3, Control Menu). The appropriate item will be un-greyled depending on the current state of the service. If the service is currently started, select 'Stop Service' to stop the service, and 'Start Service' to start it.

The service may also be controlled through the operating system's management console. To open click Start, right-click 'Computer', and select 'Manage'. Then open up 'Services and Applications', and select

'Services'. You may need to type in an administrator password.

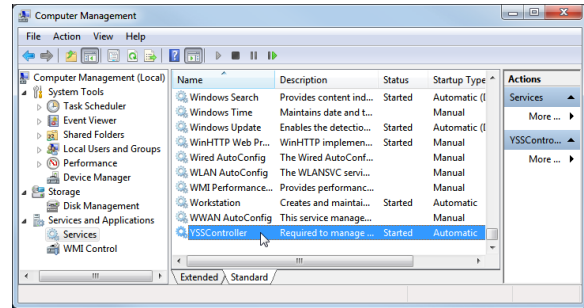

The YSSController should appear in the list of services under the name 'YSSController'. It should have a Startup Type of 'Automatic', meaning it will run on reboot, and status 'Started' if running.

Finally, the service may be controlled using the /start and /stop switches of YSSService.exe. See section 17.2, YSSService.exe switches.

**7. RUNNING THE USB CLIENT**

**7.1. Starting the Client**

The USB client allows a user to view the current controller state and to manage the controller.

To start the client is usually only necessary to run YSSController.exe. See section 6.1, Understanding execution modes for further information.

You can force YSSController.exe to run as a client by using the /client switch.

A user should run just one copy of the client. It is possible for more than one copy to be running, in which case an identical set of status icons will appear in the task tray.

**7.2. Client Status Icon**

The client is visible as a small icon in the service tray, located in the bottom right of the Windows desktop.



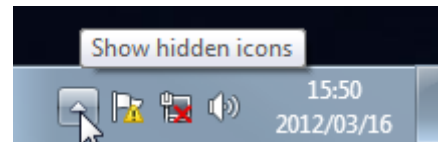

Note: On Windows 7 or later the icon may be hidden. Click the arrow as indicated in the figure below to display all of the service tray icons. The icon may be made permanently visible by selecting the 'Customize...' link in the service tray, locating the sync station icon, and then selecting 'Show icon and notifications'.



As a rule, one icon per plugged in sync station is visible to indicate the status of that sync station. If there are no sync stations plugged in then only one



icon with the 'Unplugged' status is visible. The possible status icons are listed below.

Icon	Status	Description
	No controller	The client was unable to connect to the sync station controller.
	Unplugged	There are no sync stations plugged in.
	Ready	Sync station is idle and ready for key insertion.
	Key present	A key is present and active.
	Failed	A sync station has experienced an error.

In a new installation with just a single sync station plugged in you should see a single 'Failed' status icon, as the sync station will still have to be registered. Follow the web site registration procedure described in section 9, *Registering a Sync Station* to register the sync station on the web site.

Further information can be obtained about the state of a sync station by hovering the mouse over the status icon. The sync station controller menu can be accessed by right-clicking a status icon.

### 7.3. Control Menu

The control menu for a sync station / controller may be accessed by right-clicking a sync station status icon. An example of the control menu appears below.

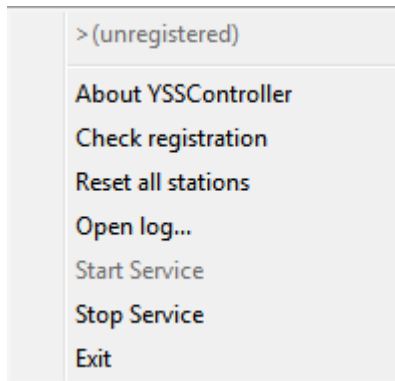

At the top of the menu appears the location of the sync station. This is the location entered into the 'Location' field on the management web site when a sync station is registered, and is only configurable on the web site. If the sync station is not registered this will display '(unregistered)'.

The remaining menu items are described below.

Item	Description
About	Displays the 'About' box for the

YSSController	sync station controller. This may be used to obtain the software version of the currently running sync station software.
Check Registration	Force a check the registration status of all connected sync stations. This will cause the sync station to contact the server and verify it is correctly registered. This may be used to update the registration status after entering a new registration key.  Note: An unregistered sync station will check its registration status every five minutes in any event.  Note: An unregistered sync station may be forced to check its registration by inserting a key.
Reset all stations	This causes the sync station controller to perform a hardware reset on all connected sync stations. This should have the same effect as unplugging the sync station and re-inserting.
Open log...	Open the sync station controller log.  Note: Depending on the log configuration, this may only contain events from the time the sync station controller was last started.
Start Service	Start the sync station controller.  Note: This item is only visible if the application is installed as a service.  Note: This will be greyed out if the service is already running, or if the user does not have permission to start the controller service.
Stop Service	Stop sync station controller.  Note: This item is only visible if the application is installed as a service.  Note: This will be greyed out if the service is not running, or if the user does not have permission to stop the controller service.

Exit	<p>Exit the client application.</p> <p>Note: If the application is only running as a client, this will not stop the service.</p> <p>Note: If the application is being run as a controller as well, then this will stop the controller and the sync stations will no longer run.</p>
------	---

**8. INSTALLING A GSM SYNC STATION**

**8.1. Requirements**

To install a GSM sync station the following is required:

Requirement	Description	Ok?
Mains power	<p>Access to mains power.</p> <p>Note: Any +5V USB power supply delivering more than 1.5A may be used. If a battery is installed a 1.0A supply may be used.</p>	
GSM coverage	<p>Acceptable GSM coverage signal strength.</p> <p><b>Check:</b> A typical cell phone should indicate at least 2 bars strength at the proposed site of installation. A portable GSM station should show more than -91 dBm (see Figure 8). If the signal is poor consider using an external antenna.</p>	

**8.2. Power precautions**

A +5V/2.0A USB2.0 conformant power supply with a cable up to 12 feet / 6m will delivery sufficient power to operate the GSM module without battery backup. With a battery backup a 1.0A or 100mA USB port may be used.

If a cable run longer than 6m is required a battery should be installed, or the USB supply should be brought closer to the station using a mains cable.

GSM may usually be run off USB port power without a battery but due to variability in power quality reliable function is not guaranteed, and peak power demands may over-stress the host system.

**8.3. Power connector**

The station uses a standard micro-USB-B connector to supply power. USB cables and power supplies with this connector are available from many suppliers.



Figure 5: Micro-USB connector

**8.4. Installing the GSM module**

Note: Typically a unit will be delivered with the module factory installed. These instructions are provided for field installation by trained personnel and if performed incorrectly may result in damage to the unit.

To install the GSM module:

1. Remove the 8 housing screws using a Torx T8 bit.
2. Prior to handling the GSM module, touch an earthed conductor ensure discharge of any static.
3. Place the module with the antenna socket towards the top of the unit.
4. Ensure the connector pins on both sides of the module are properly lined up before pressing them into the sockets.
5. Attach the antenna pigtail.

**8.5. Installing the GSM external antenna**

The external antenna requires holes to be drilled into the top of the housing and wall mount cap at the locations indicated in the plastic in order to accommodate the GSM external antenna connector.

The box requires a 6.5mm hole, and the wall mount cap a 9.5mm hole. Depending on the bit used the wall mount cap may require a 5mm pilot hole, in which case use a 9.4mm bushing to locate the 5mm bit in the jig.

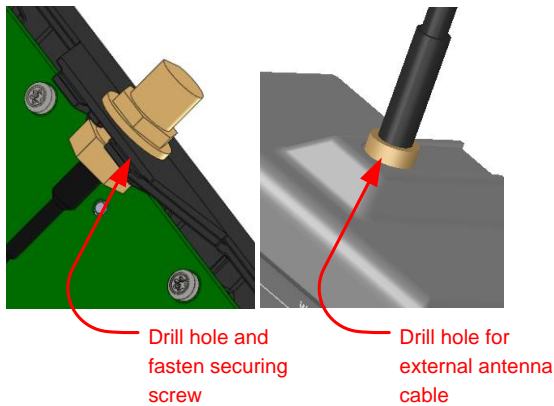

Accurate placement requires use jig. Suitable dimensions are given in Figure 6 and Figure 7.

If you intend to use an external antenna on individual units you may specify when ordering the unit.

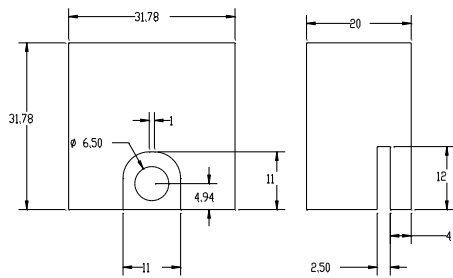

Figure 6: Jig for drilling GSM antenna hole in box

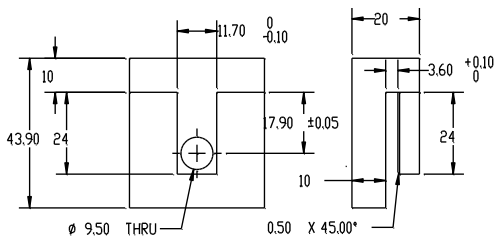



Figure 7: Jig for drilling GSM antenna hole in wall mount



**8.6. Installation Procedure**

The installation procedure is as follows:

1. Prepare the chosen table or wall mounting as per instructions included in the package.
2. Prepare the power supply cabling and fit to length.
3. Insert the USB plug and verify the power icon  comes on.
4. Seat the Secure the unit with the provided fixing screws and/or double-sided tape, as appropriate.

5. If using an external patch antenna, adjust the location to obtain the optimal reception using the signal strength indicator. See section 8.8, *GSM Signal Strength Indicator*.
6. Once the sync station is able to connect to the GSM network it will attempt to register with the server. Registration will usually take about 30 seconds. Upon successful completion the station will display the user-assigned sync station name and the legend 'Ready'.
7. If the sync station is not registered the displayed pass key must be entered into the user account. See section 9.3, *Registering a GSM Sync Station*. The sync station will attempt to register once every two minutes until the correct pass key has been entered on the web site.

**8.7. GSM Power Status Indicator**

When the GSM station is operating on battery power the 'using battery power' icon  is lit. When installing a sync station with a battery backup ensure this icon turns off and is replaced by the 'using external power' icon  when the PSU is plugged in.

**8.8. GSM Signal Strength Indicator**

The GSM signal is displayed as a job-sided pyramid icon on the bottom right of the display.







Icon	Strength	Description
	<-113 dBm	No signal or unable to connect
	< -91 dBm	Terrible, probably unreliable
	< -79 dBm	Bad, usable but speed may be compromised
	< -65 dBm	Ok
	< -53 dBm	Good
	> -53 dBm	Excellent

Figure 8: Signal strength icons

Signal strength may vary depending on climactic conditions. Stations using internal antennas may indicate varying signal strength as users move about.

### 8.9. GSM Enable / Disable and failover

An installed GSM module may be disabled using the configuration menu. To enable or disable:

1. Press and hold the 'activate menu' (0 key) button.
2. Select 'Channels' (2 key).
3. Select 'GSM' (2 key).
4. Select 'Disable' (1 key) to disable, or 'Primary' or 'Secondary' (2 or 3 key) to enable. See section 11 for a description of primary and secondary failover.

See section 11, *Service Failover* for a full description of failover.

## 9. REGISTERING A SYNC STATION

### 9.1. About Registration

A sync station cannot be used until it is registered with an account on the management system at <https://secure.yebotech.com>.

In order to register the sync station you need access to a management account. Usually a sync station is permanently attached to a single account, and may only be used for locks and keys managed by that account.

Note: You need to have 'Manage Sync Stations' permission on the account. This is available to 'Installer' and 'Account Superuser' roles.

### 9.2. Registering a USB Sync Station

If you have a sync station controller running and you plug a new sync station into a USB port, the following happens:

1. The sync station controller recognizes the presence of the sync station. A new sync station status icon appears in the service tray.
2. The Yebo server is contacted to check the sync station's registration status.
3. If the sync station is not registered, the sync station's status icon displays 'Failed': . The controller then generates a temporary 6-character pass key. This key is displayed on the sync station display, and may also be accessed by hovering the mouse over the sync station's status icon. An example of a pass key is 'SJ2GKL'.
4. Using a web browser, connect to <https://secure.yebotech.com> and log into the account on which the sync station is to be registered. Access the 'Sync Stations' menu item and use the 'Add' button to enter the sync station's temporary pass key and location.

Note: If there is an existing sync station that is being replaced or for some reason the sync station has lost its registration information, then you can use the 'Re-register' to enter a temporary pass key for the existing sync station.

5. Wait for a few minutes, or right click on the status icon and access the 'Check Registration' menu item, or insert a key into the sync station. The sync station contacts the server using the temporary pass key, and is issued with a permanent pass key. The status icon should now show 'Ready': . The sync station's display should also show 'Ready'.
6. The sync station is now registered.

### 9.3. Registering a GSM Sync Station

If you have a GSM sync station that has been able to reach the server and has verified it is not registered, the temporary 6-character pass key will be displayed on the sync station display. The registration procedure on the web site is identical to that described in section 9.2 above.

An unregistered GSM sync station will check its registration once per minute. After entering the required pass key on the web site, just wait a few seconds until the station checks again.

### 9.4. Registration on multiple services

A sync station only needs to be registered once with one registration code to be registered on both USB and GSM services. Note however that on start-up all services register via their respective channels. During this period the station displays the registration progress from each channel. Usually USB will register very quickly and GSM after about 30 seconds. If you register on USB first it may take GSM up to two minutes to complete registration.

The registration state on each channel is indicated on the server in the sync stations list under the "Address" column. The following are examples:

SM-N8703:192.168.0.9

Station is registered only on USB, host name and IP address provided.

8952000000001234567

Station is registered on GSM, SIM card ICCID number provided.

SM-N8703:192.168.0.9/8952000000001234567

Station is registered on both USB and GSM.

### 9.5. Registration Tips

1. Temporary pass keys are re-generated every time a sync station is plugged in or initialized. Ensure that the pass key you are entering is the pass key currently being displayed on the sync station.
2. If a sync station was installed to be run as an application and a designated user account, then that user must always run the sync station controller. If another user attempts to run the controller then the sync station will have to be re-registered.
 

Note: The new registration only takes effect when the temporary pass key is entered. If the designated user runs the controller without the sync station having been re-registered then the sync station will not need to be re-registered.
3. If for any reason a sync station loses its registration, but the account to which it is attached has not changed, then use the 'Re-register' button to enter the new temporary pass key. It is not necessary to delete and re-add the sync station.
4. If a site has multiple sync stations attached to the same workstation, then after registration a sync station may be identified by right-clicking to obtain the sync station control menu. The sync station's location (as entered on the web site) will be displayed in the bubble help or at the top of the control menu.
5. A specific piece of sync station hardware may be locked to an account by selecting the 'Lock to account' option in the sync station properties dialog on the web site. This will prevent the sync station from being re-registered on another account, providing a means of theft deterrence.

Note: For security reasons an unregistered sync station does not display information about the account on which it is registered. Locking a sync station to an account which cannot be subsequently identified may thus render the sync station unusable.

### 9.6. Relocating a Sync Station

Usually a sync station is permanently attached to one account. If you have 'Relocate Sync Stations' permission then you may relocate an already registered sync station you own to any account to which you have access. This permission is available to 'Installer' roles and is a useful facility if you need to support multiple sites.

If you have relocate permission:

1. Register your sync station on any account to which you have access. In the sync station

properties dialog, select the 'Ownership' tab, and in 'Owning user' select yourself.

Note: The 'Ownership' tab is only visible if you have 'Relocate Sync Stations' authorization.

2. Assigning ownership of the sync station to yourself causes the sync station to be always listed in every account to which you have access, even if the currently selected account is not the account to which the sync station is attached; and it will only be visible to yourself. If ownership is 'none' (the only other available option), then the sync station only appears on the account to which it is attached, for all users.
3. To relocate a sync station, access the 'Sync Stations' menu item on any account, access the 'Ownership' tab for the relocateable sync station, and select the account to which the sync station is to be relocated.

Note: Sync station relocations appear on your audit trail and on the affected account's security exceptions advisory.

## 10. BATTERY

### 10.1. About the battery

The battery is a lithium cell with a 1,700mAh minimum capacity, over-charge and discharge protection, and temperature monitoring. It may be ordered with the station or obtained from an alternate supplier, product code LP103450.

### 10.2. Battery shipping

Lithium battery shipping regulations require devices to be shipped with the battery disconnected. Prior to installation open the unit and connect the battery.

### 10.3. Battery charging

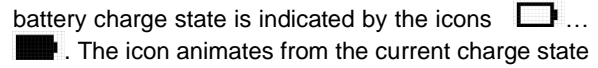
The battery charge rate is limited to 90mA, the lowest rate supported by USB2.0. Consequently it may take as long as 24 hours to fully charge the battery. The battery charge state is indicated by the icons . The icon animates from the current charge state to full as long as the battery is still charging.

### 10.4. Battery power saving mode

When the device is operating only on battery the display and illumination lights will go out after 10 seconds of non-use. Touch any button or insert a key to re-light the device.



**10.5. Battery endurance**

The battery is intended primarily as a backup to power failure, but may also be used in mobile applications.

When operating a GSM station, battery standby life is at least 24 hours. When operating as a mobile PIN station with battery support, battery life is at least 48 hours.

**10.6. Battery maintenance**

Do not permit the battery to remain in a fully discharged condition for extended periods of time as this may affect battery capacity. After connecting the battery the unit should be kept connected to a PSU.

**10.7. Battery fault condition**

If a fault condition is detected the battery fault icon  is displayed.

If the state of the battery is difficult to determine or out of expected bounds the unit enters a fault recovery mode during which the battery's charge state is tested. This may occur for example if the battery has been left totally discharged for an extended period. The fault recovery period may last several hours. If the fault condition does not clear within 24 hours then replace the battery.

**11. SERVICE FAILOVER**

**11.1. About failover**

The MFS may be configured simultaneously as both a GSM station and a USB station. 'Failover' then refers to GSM or USB failing over to the alternate service in the event the 'primary' service fails.

**11.2. Configuring failover**



Usually one or other of the services is configured as the 'Primary' service, and the alternate as the 'Secondary' service. When available the station will use the primary service. If the primary service fails then it will fail over to the secondary service.

To configure failover:

1. Press and hold the 'activate menu' (0 key) button.
2. Select 'Channels' (2 key).
3. Select the 'USB' or 'GSM' (1 or 2 key) to configure.
4. Select 'Disable' (1 key) to disable the service (preventing failover); 'Primary' (2 key) if this service is to be the default service; or 'Secondary' (3 key) to enable as the secondary service.

**11.3. Network status monitoring**

When a service is enabled and the station is registered the network state is tested every two hours plus or minus a random half-hour jitter, even when the station is not in use. In the event the station is unable to reach the server on the primary service, it fails over to the secondary service. If a service is failed the status is checked approximately every 5 minutes depending on the service type, and the station recovers to the primary service once the server becomes reachable again.

The service currently being used by the station is indicated by the USB icon  or GSM icon . In the event no sync service is available the station fails to PIN entry mode indicated by the PIN icon .

**12. PIN MODE**

**12.1. About PIN Mode**

PIN mode provides the ability to activate a key even if the server is unreachable by any service; or if there is no power available to the sync station.

To use PIN mode a key must be issued to a user for whom a personal PIN has been configured. The user may then enter their PIN to activate a key.

**12.2. PIN mode without battery**

In the event a station has no power and no (or flat) battery, the key is capable of powering the station in a reduced power PIN mode. This provides an emergency failover of last resort.

When a key is inserted into an unpowered station it always enters PIN mode with a reduced font size, as illustrated below. If the station has battery support then the full display mode is used.

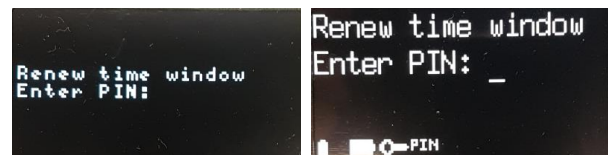

Figure 9: Key powered vs. battery supported PIN mode

**12.3. Entering PIN mode**

A station that currently supports a sync service can be forced into PIN mode by pressing the 'Enter PIN mode' (\*) button. This may be pressed prior to inserting the key, or after a key has finished syncing.

On entering PIN mode the service state icon animates between the currently active sync service and the PIN symbol. If a key is not inserted within 10 seconds, or an already inserted key is withdrawn, the mode reverts back to the current sync service.

### 12.4. Entering a PIN

When the user is prompted for a PIN, the PIN should be entered using the digit keys, followed by the 'Enter' key (#).

The 'Delete' key (\* / ←) may be used to delete the previously entered digit if in error.

On entry of a digit the digit is displayed for 1 second, then replaced by a '\*'.

### 12.5. Activating PIN protected keys

In some situations it is desirable to leave a key in deactivated mode after a sync, so a user PIN is required in order to activate the key. It may or may not be desired by the user to immediately activate the key with their PIN.

In the event a key is deactivated following sync, the user is provided with a hint "/PIN\*" as the last status entry on the display that the key is currently deactivated but that a PIN may be used to activate it. In this case the user may press the '\*' button immediately, followed by their PIN.

## 13. DEVICE ILLUMINATION

### 13.1. Illumination features

The device supports illumination of the display, buttons and keyhole for use in dark conditions.

The display uses blue OLED technology so each pixel of the display is illuminated.

Each button of the keypad is illuminated with a blue backlight. This backlight is subtle and only visible in darkened conditions.

The interior of the plug is illuminated with a blue light, making it easy to find in the dark.

### 13.2. Power saving on external power

When operating under external power, after 10 seconds of inactivity all of the illumination lights are dimmed to a lower power level. Upon activation of a button or insertion of a key the brightness is raised to the operational level.

### 13.3. Power saving on battery power

When operating on battery power all illumination is turned off after 10 seconds of inactivity.

## 14. UNIT RESET

### 14.1. About unit reset

It may happen that the base unit or some installed module gets into an unrecoverable state. Unit reset

provides a failsafe hardware-based method of forcing all devices to reset even if there is a battery installed.

### 14.2. Executing a reset

To execute a reset:

1. Press and hold simultaneously both the 2 button and the 0 button.
2. After about 5 seconds the display should go blank. If the display is already blank make sure you hold the buttons for at least 5 seconds.
3. Upon release of the buttons the display should light up and begin to display the unit initialization status.

## 15. MULTILINGUAL SUPPORT

### 15.1. About multilingual support

The MFS supports multiple languages in stand-alone mode.

### 15.2. Selecting preferred language

To select the preferred language:

1. Press and hold the activate menu button ('0').
2. Select Language ('1' key).
3. Select the digit corresponding to the desired language.

Note: at this time only English and Swedish are supported.

### 15.3. Supported fonts

The MFS supports the Latin1 (ISO8859-1) font with cp1252 extensions. This includes most diacritics used in European languages. This does not include the full Greek alphabet.

The server supports the full Unicode suite of fonts. When messages are sent to the station they are converted to the sync station supported font using "best effort". This may involve reduction of unsupported characters or diacritics to an equivalent Roman character.

### 15.4. Scope of language support

Note there are four possible loci of language support:

1. The MFS preferred language, as selected in section 15.2;
2. The GSM or YSSController applications. The GSM module only supports English. The YSSController application may depend upon the language of the host machine;

3. The account preferred language configured on the server, used in the event no user is known (for example using an un-issued key);
4. The user preferred language configured in the user to whom the current key has been issued.

## 16. TROUBLE-SHOOTING

### 16.1. Configuring the Network

In order to function the USB sync station host must have access to <https://secure.yebotech.com>. The quickest way to verify this is to type this address into a web browser on the host workstation. This should return the login prompt from the management web site.

For home and small business installations it is very unlikely there will be issues reaching the server.

Some corporate networks restrict access to all but a restricted list of hosts. In such cases the corporate's IT department must be contacted and requested the following:

- Enable HTTPS protocol packets to host [secure.yebotech.com](https://secure.yebotech.com), port 443.
- As a convenience, also open port 7 (ECHO, used by 'ping').

Even if the corporate firewall is opened to [secure.yebotech.com](https://secure.yebotech.com) (which may be verified by typing 'ping [secure.yebotech.com](https://secure.yebotech.com)' on a command prompt), it is possible that the host workstation is configured to use a proxy server that is not forwarding to [secure.yebotech.com](https://secure.yebotech.com). It is then necessary to bypass the proxy server for this address. In order to do so:

1. Run Internet Explorer.
2. Access Tools / Internet Options.
3. On the "Connections" tab, access the "LAN Settings" button.
4. If the "Use a proxy server for your LAN" checkbox is not checked, then you do not have to configure any proxy bypass. Only if it is checked, continue to the next step.
5. Click the "Advanced" button under the Proxy server settings.
6. In the "Exceptions" box under "Do not use proxy server for addresses beginning with:", enter "[secure.yebotech.com](https://secure.yebotech.com)". If there are already addresses specified, use a semicolon to separate them; for example "192.168.0; [secure.yebotech.com](https://secure.yebotech.com)".

Note: On older operating systems such as Windows XP there is a character limit of 255 characters. If this limit is exceeded, do not

remove any addresses from the bypass list without consulting the corporate's IT department as it may affect other applications on the workstation.

7. Click 'Ok' until you reach the main browser window, and then enter "[secure.yebotech.com](https://secure.yebotech.com)" into the URL box. You should be presented with the YeboManager login page.

### 16.2. Managing Hibernation

If a USB host computer goes into hibernation it will usually turn off the USB ports. The sync station will not be functional until the computer is woken up.

Usually a computer in hibernation may be woken by hitting a key, and up to a minute will be required before the sync station may be used. In such circumstances the user(s) must be trained to understand the required process.

The brute-force method is to turn off hibernation. This may be appropriate if the sync station is used through a 24-hour period. Consult the operating system documentation for the appropriate way to turn off hibernation.

### 16.3. Managing Service Configuration

YSSService.exe may be run on the command line to manage its installation configuration. Depending on the initial installation options you may need to have administrative rights.

To start a command prompt as administrator, go to Start / All Programs / Accessories, right-click Command Prompt, and select 'Run as Administrator'.

To change to the folder containing YSSController.exe:

```
cd C:\Program Files (x86)\YeboTech\YSSController
```

To display all available command-line switches:

```
YSSController /help
```

To re-install the service:

```
YSSController /reinstall
```

To restart the service:

```
YSSController /restart
```

To grant ordinary users the ability to start and stop the service:

```
YSSController /grantall
```

To specify a fixed location for a log file and enable event logging, and have these used every time the controller is started:

```
YSSController /log c:\yssc.log
```

```
/diag 1 /persist /exit
```

See section 17, *APPENDIX: Command Switches* for a full description of available switches.

**17. APPENDIX: COMMAND SWITCHES**

**17.1. General remarks about switches**

Both YSSService.exe and YSSController.exe can be executed with command-line switches to control their behaviour and installation.

Generally:

1. All switches are preceded by a '/'.
2. Switches are case-insensitive.
3. Multiple switches may be specified.
4. With the exception of /fork, the order of switches doesn't matter. When multiple switches are specified they are executed in the 'logical' order.
5. The arguments for switches that take arguments must follow the switch separated by white space.

Example: /diag 1

6. Arguments that contain white space must be enclosed in double-quotes.

Example: /log "My log file.log"

7. The application will return an error code of zero if no error occurred processing switches, otherwise it will return the Windows error code of the failing operation. This code is accessible in the command shell via the %ErrorLevel%.

**17.2. YSSService.exe switches**

The YSSService.exe application is normally run by the system as a service. This is its default behaviour when run without any command-line switches. It may also be run from a command prompt to configure the service installation.

The following switches are supported:

Switch	Description
/help	List application information and all available switches.
/uninstall	Uninstall the YSSController service. This will first stop the service if it is currently running.  Note: this does not un-install the application, just the service.
/install	Install this application as a system service. This will fail if the service is already installed.

/reinstall	Re-install this application as a system service. If the service is already installed it will be first un-installed. This will not affect existing registry settings.
/stop	Stop the YSSController service.
/start	Start the YSSController service. This will fail if the service is already running.
/restart	Re-start the YSSController service. If the service is currently running it will first shut it down before re-starting.
/grantstart	Grant 'Everyone' the right to start the service.
/grantstop	Grant 'Everyone' the right to stop the service.
/grantall	Grant both start and stop access to 'Everyone'.
/console	Run the service as a regular console-mode application. All output to the error log is echoed to the display. Hit <Enter> to exit the application.
/log [<file>]	Specify the name of the log file to log to. If <file> is not specified the default temporary file is used.
/diag [<n>]	Set the diagnostic level: 0 = errors only (default), 1 = activity, 2 = messages, 3 = both.  Note: Message logging will fail unless run as an administrator.  Note: If <n> is not specified, the default is 0 = errors only.  Note: Activation of message logging is recorded in the sync station's audit trail and raised on the security exception report.
/persist	Write the /log and /diag settings to the registry.
/exit	Exit the application after processing the switches. This is implied by /help, /uninstall, /install, /reinstall, /stop, /start, /restart, /grantstart, /grantstop, /grantall.

Examples:

To force a re-install, grant start and stop access to all users, and start:

```
YSSService /reinstall/grantall/start
```

To run as a console-mode application and log activity to the console:

```
YSSService /console/diag 1
```

**17.3. YSSController.exe switches**

YSSController.exe is normally run as a user application. The following switches are supported:

Switch	Description
/help	Display a dialog listing all available switches.
/about	Display the application's 'About' dialog.
/stop	Stop all running instances of YSSController and exit.  Note: This may fail if the account executing this command lacks sufficient privileges.
/fork	Fork a new copy of this process and then immediately exit. All switches following '/fork' are passed to the new application.  Note: switches prior to /fork are processed before forking.
/diag [<n>]	Set the diagnostic level: 0 = errors only (default), 1 = activity, 2 = messages, 3 = both.  Note: Message logging will fail unless run as an administrator.  Note: If <n> is not specified, the default is 0 = errors only.  Note: Activation of message logging is recorded in the sync station's audit trail and raised on the security exception report.  Note: this switch is only applicable if application is running as a controller.
/log [<file>]	Specify the name of the log file to log to. If <file> is not specified the default temporary file is used.  Note: this switch is only applicable if application is running as a controller.

/client	Force the application to run as a client and not as a controller.  Note: If YSSController is installed as a service then this is implied, even if no controller is running. This behaviour may be overridden by specifying the /controller switch.
/controller	Force the application to run as a controller.  Note: This will fail if there is already a controller running.
/nogui	Do not enable the client graphical interface when running as a controller. This implies /controller.  Note: When run with this option there will be no visible interface. The only way to stop the application is for the user to log out, or to locate YSSController in the task manager and shut it down.  Note: When started as a service, /noclient is implied.
/noclients	Prevent clients from connecting to the controller. This implies /controller.
/persist	Write the /log and /diag settings to the registry.
/exit	Exit the application after processing the switches. This is implied by /help, /about, /stop, /fork.

**18. APPENDIX: KEYPAD REFERENCE**









Function	Keys
Reset	This performs a hardware reset on the base unit and all installed modules.  Press '2' and '0' (center column keys) simultaneously for at least 5 seconds. When the display goes blank release to allow the unit to reset.
Open menu	This opens the configuration menu.  Press and hold '0' for 0.5 seconds.  Note: this function is disabled if the user is being prompted for a PIN.
Select menu	Select a displayed menu item.





item	Press a digit '1'...'9' corresponding to a displayed menu item.  Note: the currently selected menu item is highlighted as inverse.
Previous menu	Return to a previous menu. Press '*' (Back).  Note: If there is no previous menu normal function is resumed.
Enter PIN mode	Force PIN-entry mode even if the device is currently able to sync with the server.  Press '*'. The service icon should begin to alternate with 'PIN'. On completion of PIN entry, removal of key, or timeout of 10 seconds, or a second press of '*', the MFS reverts back to normal sync mode.  Note: this function may be used at the end of a sync prior to key removal.
Enter PIN	Enter a PIN when prompted.  Press the digits 0...9 to enter the PIN, then press '#' (Enter) to finish.
Delete entry	Delete the last entered digit. Press '*' (Back).

**19. APPENDIX: STATUS ICONS**

Note: status icons are always displayed in the bottom row in a 'slot' corresponding to major functions. Variants of an icon may appear in a particular slot, or it may be animated to indicate an active state.

#	Slot	Icons
1	Power	Indicates power status.  Power from USB port  Using battery
2	Battery	 Battery fault or state unknown.  ...  Battery charge, animates to current charge state when charging.
3	Key	 Key idle  Key busy  Incomplete, re-insert

4	Service	<b>PIN</b> In PIN mode  Syncing via USB  Syncing via GSM
5	Signal	 Signal strength (see Figure 8).

**20. APPENDIX: CONFIGURATION MENUS**

Notes:

1. To enter menu mode, press and hold '0'.
2. Press a digit to select a menu item.
3. Press \*/← (Back) to return to previous menu.
4. Press \*/← (Back) repeatedly to exit menu mode.
5. If idle in menu mode for 10 seconds the station reverts to ready mode.

Menu	Description
Settings (main menu)	1: Language 2: Channels
Language (setting)	Configure the default language for the station in stand-alone mode. When connected as a sync station the language may differ depending on account and user preferences on the server.  1: English 2: Swedish
Channels (submenu)	Select the communications channel to configure.  1: USB 2: GSM
Channel (setting)	Configure the selected channel.  1: Disable 2: Primary 3: Secondary  'Disable' disables the channel even if the hardware is installed. 'Primary' selects the channel in preference to any other available channel. 'Secondary' relegates the channel to a fail-over channel in the event there is no primary channel available.

**21. APPENDIX: SUPPORTED CHARACTERS**

The characters supported by the MFS are listed in the table below. Those codes not described are represented as blank space.

0x20		space	0x90		
0x21	!	exclam	0x91	'	leftquotesingle
0x22	"	quotedbl	0x92	'	rightquotesingle
0x23	#	numbersign	0x93	"	leftquotedouble
0x24	\$	dollar	0x94	"	rightquotedouble
0x25	%	percent	0x95	•	bullet
0x26	&	ampersand	0x96	–	ndash
0x27	'	quotesingle	0x97	—	mdash
0x28	(	parenleft	0x98		
0x29	)	parenright	0x99	™	trademark
0x2a	*	asterisk	0x9a	š	scaron
0x2b	+	plus	0x9b	›	rightanglesingle
0x2c	,	comma	0x9c	œ	smallligature
0x2d	-	hyphen	0x9d		
0x2e	.	period	0x9e	ž	zcaron
0x2f	/	slash	0x9f	ÿ	Ydieresis
0x30	0	zero	0xa0		space
0x31	1	one	0xa1	¡	exclamdown
0x32	2	two	0xa2	¢	cent
0x33	3	three	0xa3	£	sterling
0x34	4	four	0xa4	¤	currency
0x35	5	five	0xa5	¥	yen
0x36	6	six	0xa6	‡	brokenbar
0x37	7	seven	0xa7	§	section
0x38	8	eight	0xa8	¨	dieresis
0x39	9	nine	0xa9	©	copyright
0x3a	:	colon	0xaa	ª	ordfeminine
0x3b	;	semicolon	0xab	«	guillemotleft
0x3c	<	less	0xac	¬	logicalnot
0x3d	=	equal	0xad	-	hyphen
0x3e	>	greater	0xae	®	registered
0x3f	?	question	0xaf	˘	macron
0x40	@	at	0xb0	°	degree
0x41	A	A	0xb1	±	plusminus
0x42	B	B	0xb2	²	twosuperior
0x43	C	C	0xb3	³	threesuperior
0x44	D	D	0xb4	´	acute
0x45	E	E	0xb5	µ	mu
0x46	F	F	0xb6	¶	paragraph
0x47	G	G	0xb7	·	periodcentered
0x48	H	H	0xb8	¸	cedilla
0x49	I	I	0xb9	¹	onesuperior
0x4a	J	J	0xba	º	ordmasculine
0x4b	K	K	0xbb	»	guillemotright
0x4c	L	L	0xbc	¼	onequarter

0x4d	M	M	0xbd	½	onehalf
0x4e	N	N	0xbe	¾	threequarters
0x4f	O	O	0xbf	¿	questiondown
0x50	P	P	0xc0	À	Agrave
0x51	Q	Q	0xc1	Á	Aacute
0x52	R	R	0xc2	Â	Acircumflex
0x53	S	S	0xc3	Ã	Atilde
0x54	T	T	0xc4	Ä	Adieresis
0x55	U	U	0xc5	Å	Aring
0x56	V	V	0xc6	Æ	AE
0x57	W	W	0xc7	Ç	Ccedilla
0x58	X	X	0xc8	È	Egrave
0x59	Y	Y	0xc9	É	Eacute
0x5a	Z	Z	0xca	Ê	Ecircumflex
0x5b	[	bracketleft	0xcb	Ë	Edieresis
0x5c	\	backslash	0xcc	Ì	Igrave
0x5d	]	bracketright	0xcd	Í	Iacute
0x5e	^	asciicircum	0xce	Î	Icircumflex
0x5f	_	underscore	0xcf	Ï	Idieresis
0x60	`	grave	0xd0	Ð	Eth
0x61	a	a	0xd1	Ñ	Ntilde
0x62	b	b	0xd2	Ò	Ograve
0x63	c	c	0xd3	Ó	Oacute
0x64	d	d	0xd4	Ô	Ocircumflex
0x65	e	e	0xd5	Õ	Otilde
0x66	f	f	0xd6	Ö	Odieresis
0x67	g	g	0xd7	×	multiply
0x68	h	h	0xd8	Ø	Oslash
0x69	i	i	0xd9	Ù	Ugrave
0x6a	j	j	0xda	Ú	Uacute
0x6b	k	k	0xdb	Û	Ucircumflex
0x6c	l	l	0xdc	Ü	Udieresis
0x6d	m	m	0xdd	Ý	Yacute
0x6e	n	n	0xde	Þ	Thorn
0x6f	o	o	0xdf	ß	germandbls
0x70	p	p	0xe0	à	agrave
0x71	q	q	0xe1	á	aacute
0x72	r	r	0xe2	â	acircumflex
0x73	s	s	0xe3	ã	atilde
0x74	t	t	0xe4	ä	adieresis
0x75	u	u	0xe5	å	aring
0x76	v	v	0xe6	æ	ae
0x77	w	w	0xe7	ç	cedilla
0x78	x	x	0xe8	è	egrave
0x79	y	y	0xe9	é	eacute
0x7a	z	z	0xea	ê	ecircumflex
0x7b	{	braceleft	0xeb	ë	edieresis
0x7c		bar	0xec	ì	igrave
0x7d	}	braceright	0xed	í	iacute

0x7e	~	asciitilde	0xee	î	icircumflex
0x7f			0xef	ï	idieresis
0x80	€	eurosign	0xf0	đ	eth
0x81			0xf1	ñ	ntilde
0x82	,	lowquotesng	0xf2	ò	ograve
0x83	f	latinhooked	0xf3	ó	oacute
0x84	„	lowquotedbl	0xf4	ô	ocircumflex
0x85	...	ellipsis	0xf5	õ	otilde
0x86	†	dagger	0xf6	ö	odieresis
0x87	‡	dbldagger	0xf7	÷	divide
0x88	^	circumflex	0xf8	ø	oslash
0x89	‰	permille	0xf9	ù	ugrave
0x8a	Š	Scaron	0xfa	ú	uacute
0x8b	‹	leftanglesngl	0xfb	û	ucircumflex
0x8c	Œ	capligature	0xfc	ü	udieresis
0x8d			0xfd	ý	yacute
0x8e	Ž	Zcaron	0xfe	þ	thorn
0x8f			0xff	ÿ	ydieresis