

Model # YL15-PDL-05

- Features**
- 8mm hardened shackle
 - Heavy duty body
 - Open/Un-shrouded shackle
 - Removable cylinder (when un-locked)

General Description

47mm body
Steel shackle, Brass body
Chrome & satin Chrome plated
Suitable for all internal and external applications



Warranty 1 year

Ratings

Ingress protection(plug)	IEC60529	IP55
EMC/EMI	IEC61000(2,3,4,8,9)	ESD 15kV

Security

Base authorizations	162	
Key strength	64	bits
Supported protocols	SG1	
Feature class	B	(commercial)

Mechanical

Body dimensions	51 x 47 x 20	mm, H x W x T
Shackle dimensions	8 x 25 x 24	Mm, dia x I.D. x H
Accepts euro profile cylinder		

Operating life

Actuation probability	>99.0	%
Key insertions	100,000	

Multi-key limitations

Min period	8	seconds
Max period	3	days
Max keys in operation	3	
Max 'B' groups	1	

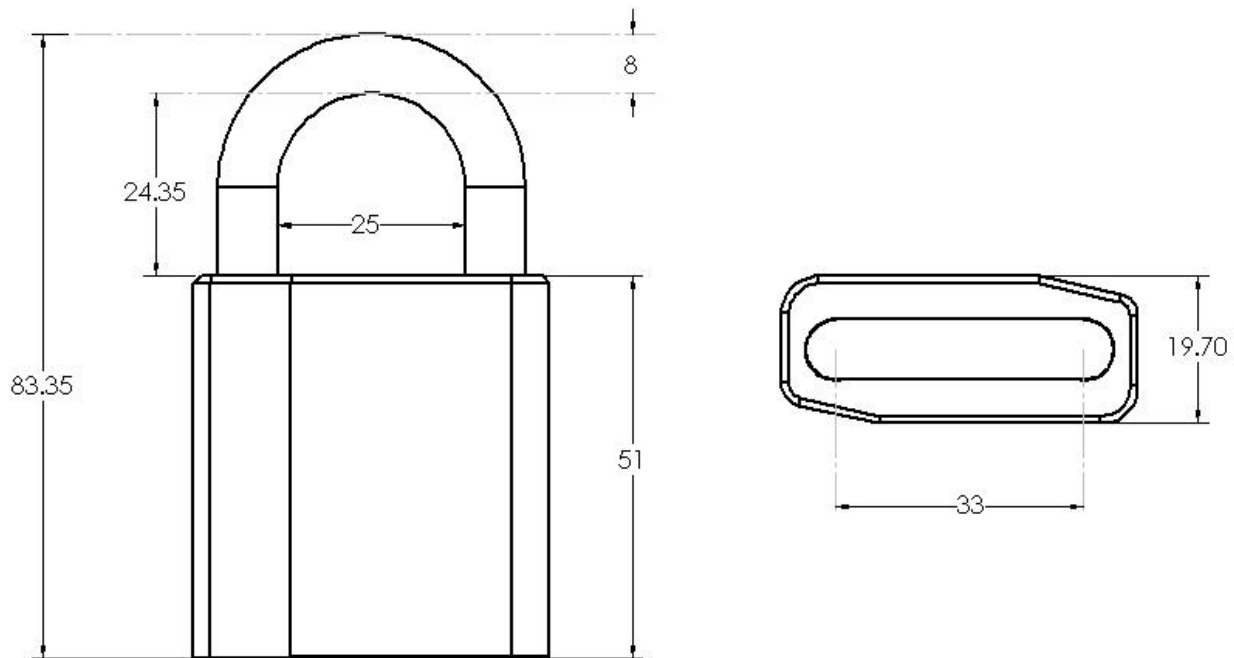

Figure 1: Padlock dimensions (mm)

Product description

The padlock is designed as a robust lock, designed to withstand various forms of abuse. The shackle is highly resistant to bolt cutters, particularly when supplied in semi-shrouded form. The shackle is locked via two steel ball bearings, and the cam is retained via a positive locking mechanism.

The product is supplied as key retaining, but a non-key retaining version is available

Terms

Multi-keying: Require more than one authorized key be inserted into the padlock within a specified time window before the padlock will open. Supports 'A' and 'B' group requirements (one or more keys from each group is required to open).

Time windowing: Restrict access to specified time periods.

Checkpoint: Double-purpose lock as a checkpoint incorporated